



HESTORE.HU

elektronikai alkatrész áruház

EN: This Datasheet is presented by the manufacturer.

Please visit our website for pricing and availability at www.hestore.hu.

DTMSS-27 SENDUST POWER INDUCTORS

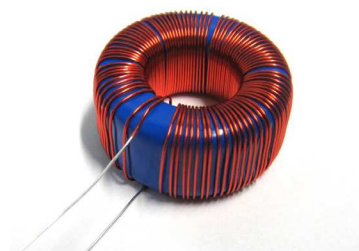

APPLICATIONS:

- interference suppressing chokes (DC - 300kHz)
- energy storage inductors (DC - 300kHz)
- DC/DC converters
- SMPS
- EMI filters (DC - 1 MHz)
- acoustic filters

ORDERING CODE:

DTMSS- 27 / 2,2 / 0,3 -V

mounting: V - vertical, H - horizontal, BV - base vertical, CV - case vertical, CH - case horizontal, KM-5 - case KM-5 type
 rated current in Amps
 inductance in mH@ $I_{DC} = 0A$
 sendust core outer diameter
 product symbol

DIMENSIONS:

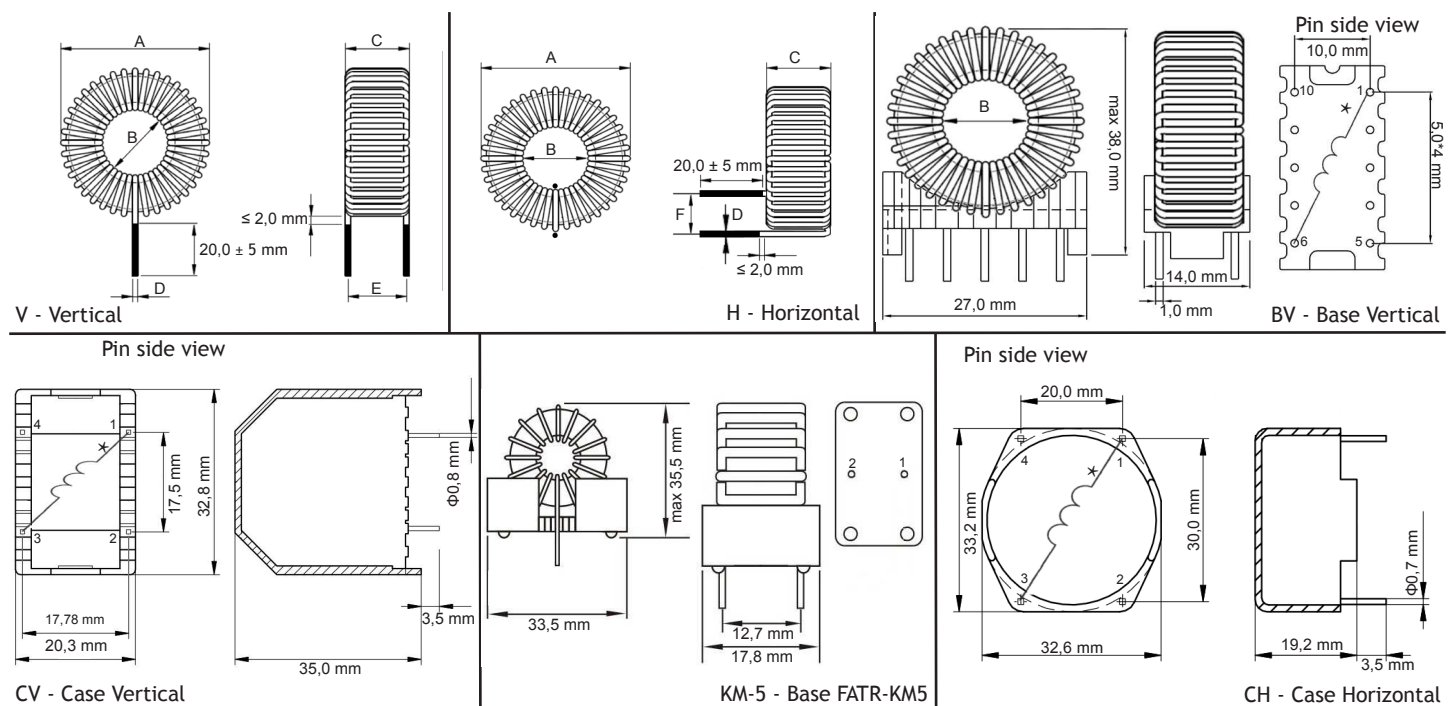

Part number	Type - core dimension ($\pm 10\%$)						Mounting version					
	A [mm]	B [mm]	C [mm]	D [mm]	E [mm]	F [mm]	V	H	BV	CV	CH	KM-5
DTMSS-27/2,2/0,3	28,5	13,5	12,5	0,20	12,5	7,5	✓	✓	✓	✓	✓	—
DTMSS-27/1,5/0,4	28,5	13,5	12,5	0,23	12,5	7,5	✓	✓	✓	✓	✓	—
DTMSS-27/1,0/0,7	29,0	13,0	13,0	0,30	12,5	7,5	✓	✓	✓	✓	✓	—
DTMSS-27/0,68/1,0	29,0	12,5	13,0	0,36	13,0	7,5	✓	✓	✓	✓	✓	—
DTMSS-27/0,47/1,6	29,0	11,5	13,5	0,45	13,0	8,5	✓	✓	✓	✓	✓	—
DTMSS-27/0,33/2,0	29,0	11,0	13,5	0,50	14,0	8,5	✓	✓	✓	✓	✓	—
DTMSS-27/0,22/4,0	30,5	10,0	14,5	0,95	14,5	10,0	✓	✓	✓	✓	✓	✓
DTMSS-27/0,15/6,0	31,5	8,5	15,5	1,15	15,5	10,0	✓	✓	✓	✓	✓	✓
DTMSS-27/0,10/8,0	31,5	7,5	16,0	1,40	15,5	10,0	✓	✓	✓	—	✓	✓
DTMSS-27/0,068/10	32,0	7,5	16,0	1,50	17,5	10,0	✓	✓	—	—	—	✓
DTMSS-27/0,047/15	32,5	5,0	16,0	1,90	17,5	11,5	✓	✓	—	—	—	✓
DTMSS-27/0,033/20	33,5	4,5	17,0	2,45	17,5	13,0	✓	✓	—	—	—	✓
DTMSS-27/0,022/30	33,5	3,0	17,0	2,80	16,5	13,0	✓	✓	—	—	—	✓

ELECTRICAL PROPERTIES:

Part number	Lmax [μH]	I _{max} [A]	L@I _{max} [μH]	RDC [Ω]	Δt [°C]
DTMSS-27/2,2/0,3	2200	0,30	2160	3,0100	7,4
DTMSS-27/1,5/0,4	1500	0,40	1460	2,2100	10,1
DTMSS-27/1,0/0,7	1000	0,70	954	1,1100	12,1
DTMSS-27/0,68/1,0	680	1,00	640	0,5750	15,2
DTMSS-27/0,47/1,6	470	1,60	429	0,2940	15,9
DTMSS-27/0,33/2,0	330	2,00	294	0,2090	19,8
DTMSS-27/0,22/4,0	220	4,00	170	0,1070	35,6
DTMSS-27/0,15/6,0	150	6,00	106	0,0541	32,9
DTMSS-27/0,10/8,0	100	8,00	68,5	0,0387	45,3
DTMSS-27/0,068/10	68	10,0	45,2	0,0197	30,3
DTMSS-27/0,047/15	47	15,0	26,1	0,0100	33,3
DTMSS-27/0,033/20	33	20,0	17,3	0,0072	38,8
DTMSS-27/0,022/30	22	30,0	9,12	0,0037	43,7

CHARACTERISTICS:

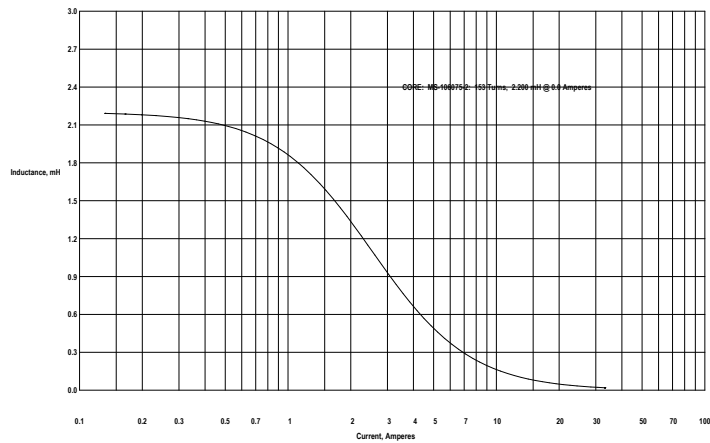

CREATED IN MICROMETALS ARNOLD POWDER CORES - DESIGN OF INDUCTORS FOR POWER FILTER APPLICATIONS Fri Nov 25 10:51:25 2011

DTMSS-27/2,2/0,3

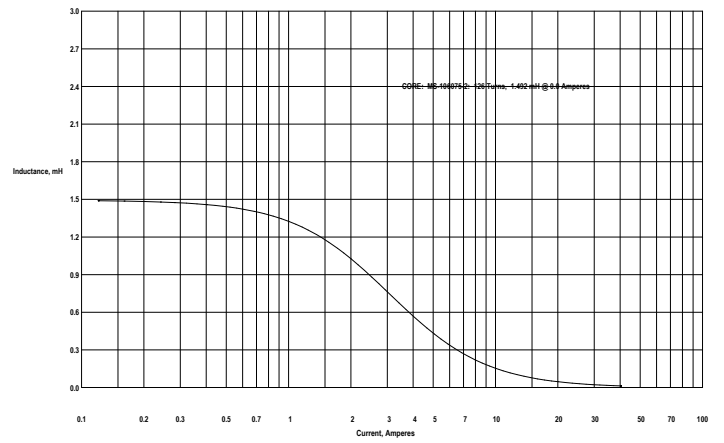

CREATED IN MICROMETALS ARNOLD POWDER CORES - DESIGN OF INDUCTORS FOR POWER FILTER APPLICATIONS Fri Nov 25 11:03:36 2011

DTMSS-27/1,5/0,4

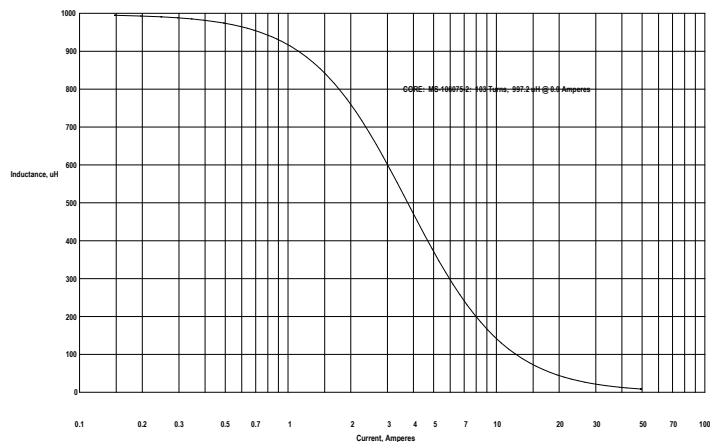

CREATED IN MICROMETALS ARNOLD POWDER CORES - DESIGN OF INDUCTORS FOR POWER FILTER APPLICATIONS Fri Nov 25 11:07:32 2011

DTMSS-27/1/0,7

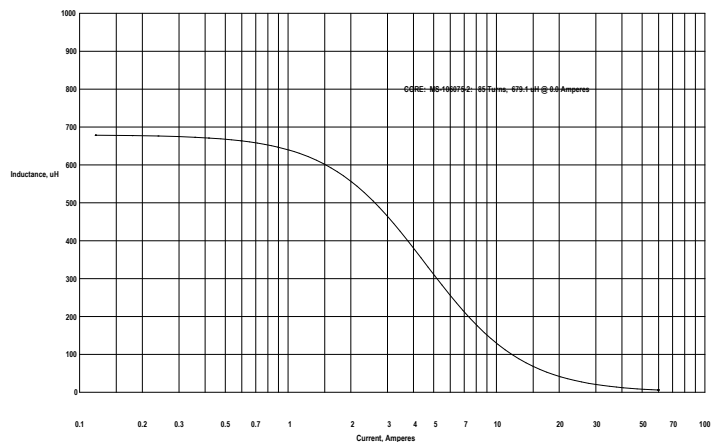

CREATED IN MICROMETALS ARNOLD POWDER CORES - DESIGN OF INDUCTORS FOR POWER FILTER APPLICATIONS Fri Nov 25 11:09:09 2011

DTMSS-27/0,68/1,0

CHARACTERISTICS:

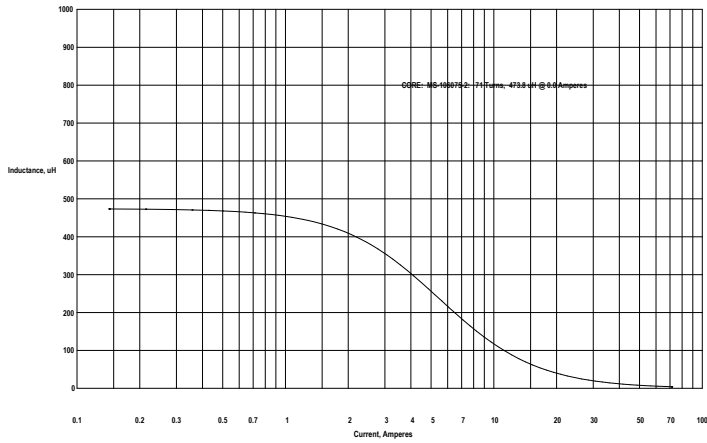

CREATED IN MICROMETALS ARNOLD POWDER CORES - DESIGN OF INDUCTORS FOR POWER FILTER APPLICATIONS Fri Nov 25 11:10:35 2011

DTMSS-27/0,47/1,6

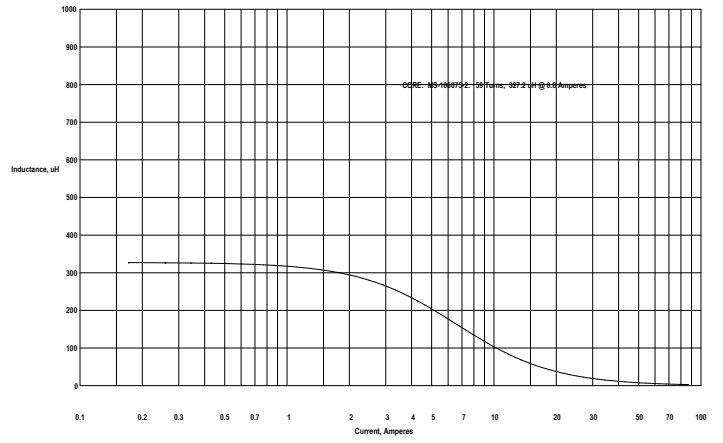

CREATED IN MICROMETALS ARNOLD POWDER CORES - DESIGN OF INDUCTORS FOR POWER FILTER APPLICATIONS Fri Nov 25 11:12:18 2011

DTMSS-27/0,33/2,0

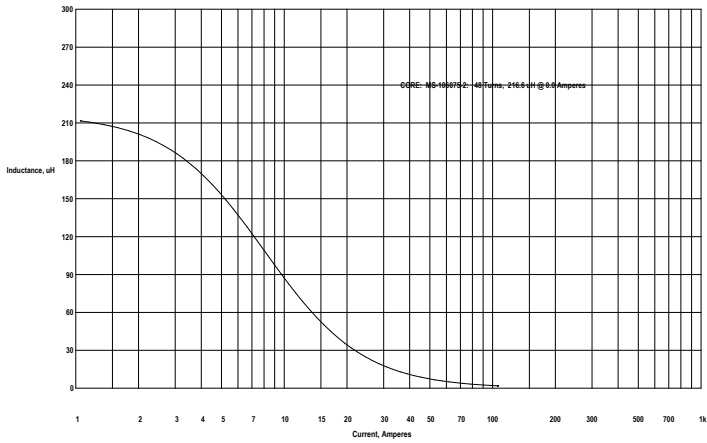

CREATED IN MICROMETALS ARNOLD POWDER CORES - DESIGN OF INDUCTORS FOR POWER FILTER APPLICATIONS Fri Nov 25 11:14:30 2011

DTMSS-27/0,22/4,0

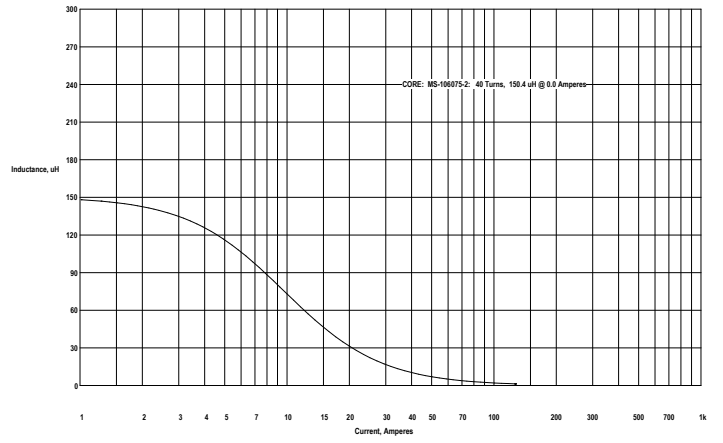

CREATED IN MICROMETALS ARNOLD POWDER CORES - DESIGN OF INDUCTORS FOR POWER FILTER APPLICATIONS Fri Nov 25 11:15:51 2011

DTMSS-27/0,15/6,0

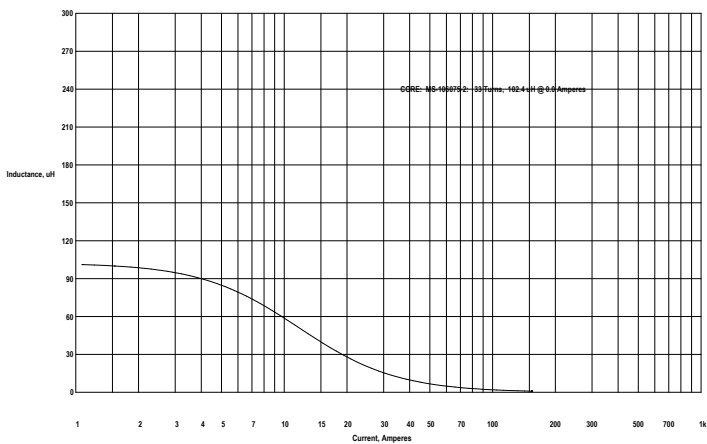

CREATED IN MICROMETALS ARNOLD POWDER CORES - DESIGN OF INDUCTORS FOR POWER FILTER APPLICATIONS Fri Nov 25 11:18:16 2011

DTMSS-27/0,1/8,0

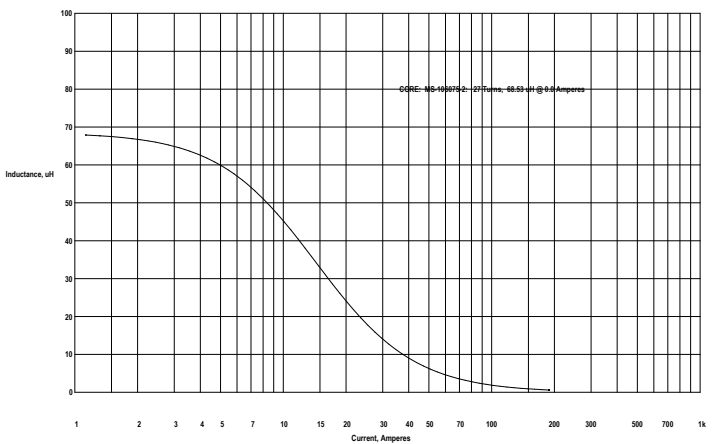

CREATED IN MICROMETALS ARNOLD POWDER CORES - DESIGN OF INDUCTORS FOR POWER FILTER APPLICATIONS Fri Nov 25 11:22:21 2011

DTMSS-27/0,068/10

CHARACTERISTICS:

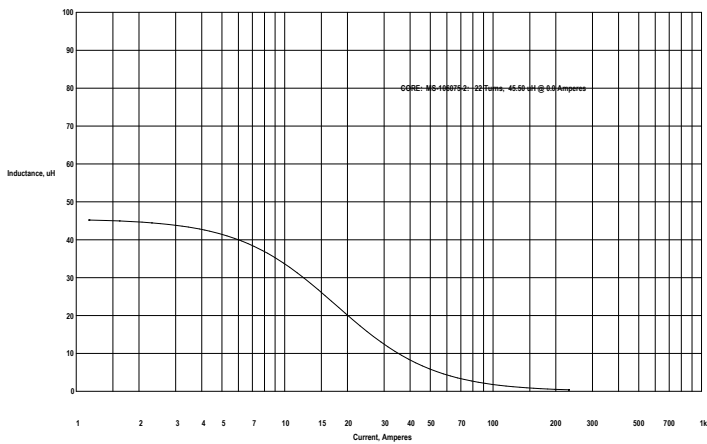

CREATED IN MICROMETALS ARNOLD POWDER CORES - DESIGN OF INDUCTORS FOR POWER FILTER APPLICATIONS Fri Nov 25 11:23:56 2011

DTMSS-27/0,047/15

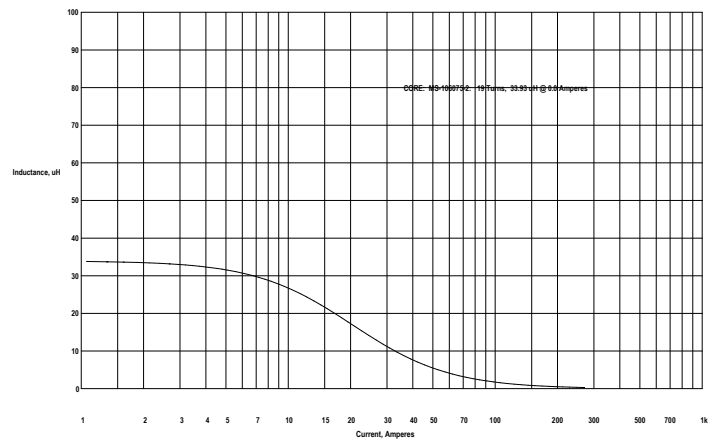

CREATED IN MICROMETALS ARNOLD POWDER CORES - DESIGN OF INDUCTORS FOR POWER FILTER APPLICATIONS Fri Nov 25 11:26:27 2011

DTMSS-27/0,033/20

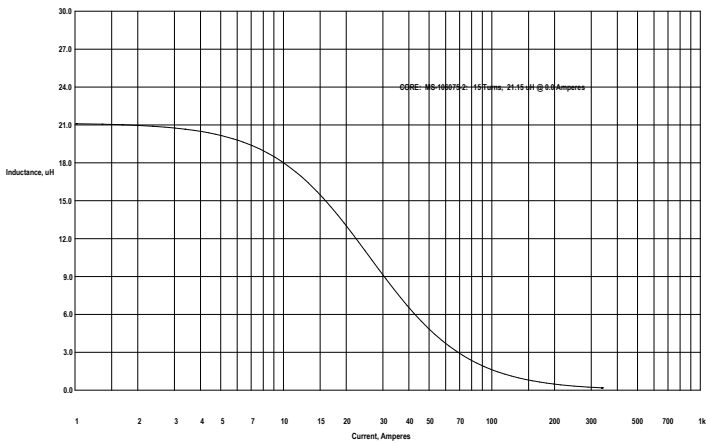

CREATED IN MICROMETALS ARNOLD POWDER CORES - DESIGN OF INDUCTORS FOR POWER FILTER APPLICATIONS Fri Nov 25 11:31:25 2011

DTMSS-27/0,022/30